

HSF

NOTES:

1. Insulator material: PA9T+G.F, UL94 V=0;
2. Terminal material: Copper Alloy;
Terminal Plating: Au/Sn Plated Over Nickel ;
3. Rated Voltage: 50V;
4. Rated Current: Power 30A; Signal 2.5A;
5. Contact Resistance:
Power 0.7mΩ Max; Signal 2010mΩ Max;
6. Insulation Resistance: DC500V
Power 10000MΩ Min; Signal 500MΩ Min;
7. Insulation Withstand Voltage:
Power 2500VAC/1min; Signal 1000VAC/1min ;
8. Durability :200 cycling;
9. Operation Temperature:-20°C to +105°C;

Ordering Information:

PMR XX A - XX - XXX - XX A M X1

Contact Plated:
S3=10u" Gold /Tin
S4=15u" Gold /Tin
S5=30u" Gold /Tin

No. Left Power:
05=5Pin
20=20Pin
No. Signal:
004=4Pin
148=148Pin

No. Right Power:
05=5Pin
20=20Pin
TAIL OPTIONS:
A=3.43mm
B=2.29mm
C=4.19mm
D=3.91mm

Fixed Mode:
M: Solder TO Board
K: Press Fit
N: No fixed type

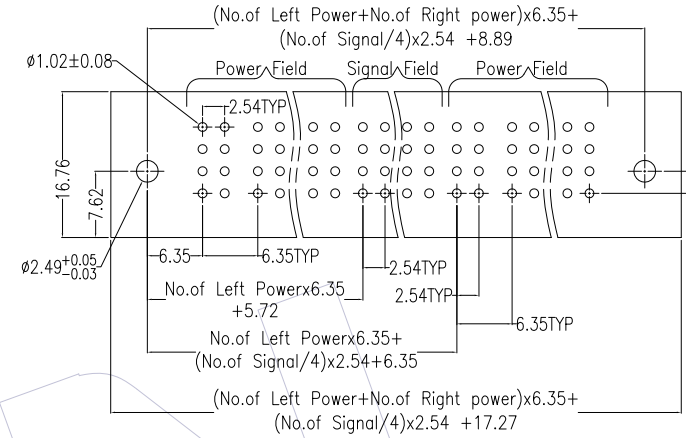
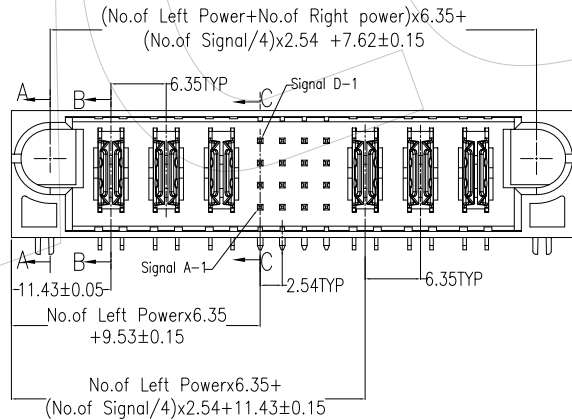
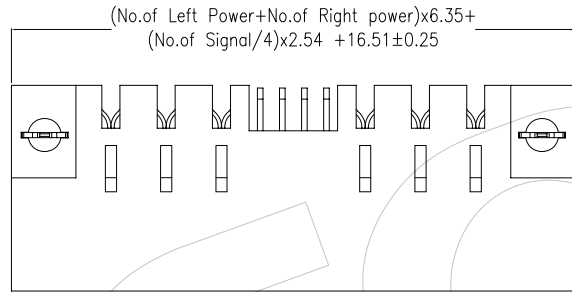
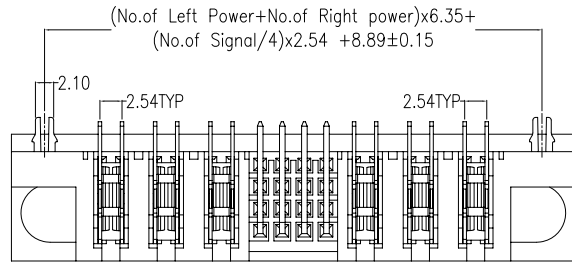

Recommended P.C.B Layout(Top Side)
(PCB BOARD TOLERANCE±0.05)

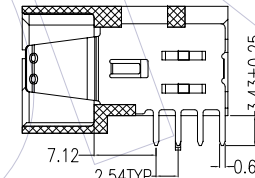

SECTION: B-B

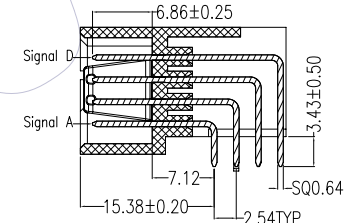
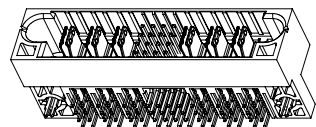
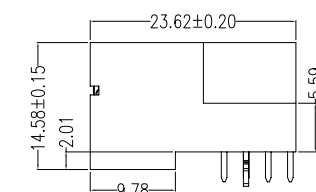

SECTION: C-C

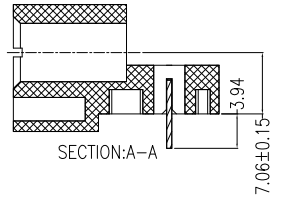

SECTION: A-A

REV	DATE	MODIFICATION DESCRIPTION	CHANGE	OPERATION		DRAW Houfu Peng	DATE 16/11/01	SCALE UNIT	FIT mm inch	PART NO. PMRXX A-XX-XXX-XXAMX1	TITLE: PSP A TYPE 90° MALE DIP
				X.X	±0.40						
				X.XX	±0.25	CHECK	DATE	SIZE	A4		
				X.XXX	±0.15	APPROVE	DATE	SHEET	1/1	Customer NO.	
				Angle	± 3'			PROJ.			
				DIM	TOL						

WCON
Http: www.wcon.com

WCON-Dongguan Tel: +86 769 85358920 Fax: +86 769 85358915 E-mail: sales@wcon.com
WCON-Kunshan Tel: +86 512 57468408 Fax: +86 512 57468468 E-mail: salesks@wcon.com